

Amphenol

Fiber Optic Solutions

EWOC

Environmental Weatherproof Optical Connectors
TVOP - LJTOP - RNJOP - STARTOP

butt joint connectors
harsh environment

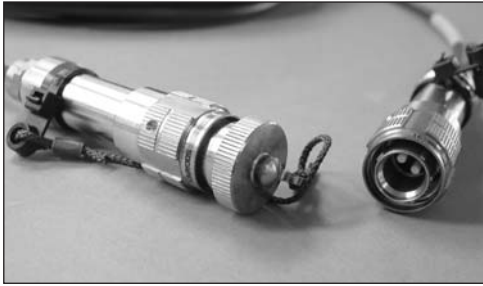

TVOP, LJTOP, RNJOP and Startop product range offers the most comprehensive range of ruggedized optical connectors based on MIL DTL 38 999 Series and its derivatives. More than ten years ago, Amphenol developed the first generation of optical termini for multiway connectors in accordance with the MIL 29504 specification. Combined with the MIL DTL 38 999 serie III shells, the Startop offers the intermateability with other MIL 29504. The new generation TVOP, LJTOP, RNJOP uses the proven 38 999 or derivated shell, and the standard termini (\varnothing 2.5 mm) which is designed to provide a high reliability performance and cost effectives solutions for outdoor and indoor applications.

These products are widely used in navy, rail + mass transit, industrial, aeronautic civil and military applications.

- Wide range of various locking mechanism :
 - Screw
 - Bayonet
 - Rackable
- Developed for 100% Scoop proof and blind mating
- Up to 8 channels
- Wavelength 850 - 1300 nm -1550nm
- Multimode for all series
- Singlemode for TVOP and LJTOP

Table of contents



TVOP, LJTOP, RNJOP, STARTOP BUTT JOINT TECHNOLOGY KEY FEATURES	p4
Insert Arrangement	p4
TECHNICAL SPECIFICATIONS	p5
TVOP	p6
TVOP Plug : TVOP 06	p7
How to order TVOP Plug	p7
TVOP Receptacle : TVOP Jam Nut Receptacle : TVOP 07	p8
How to order TVOP Jam Nut Receptacle	p9
TVOP Square Flange Receptacle : TVOP 00	p9
How to order TVOP Square Flange Receptacle	p10
How to order TVOP Dust Caps	p11
LJTOP	p12
LJTOP Plug : LJTOP 06	p13
How to order LJTOP Plug	p13
LJTOP Receptacle : LJTOP Jam Nut Receptacle : LJTOP 07	p14
How to order LJTOP Jam Nut Receptacle	p15
LJTOP Square Flange Receptacle : LJTOP 00	p15
How to order LJTOP Square Flange Receptacle	p16
LJTOP Protective Caps	p17
How to order LJTOP Dust Caps	p17
RNJOP	p18
RNJOP Plug* : RNJOP 06	p19
How to order RNJOP Plug	p19
RNJOP Jam Nut Receptacle * : RNJOP 07	p20
How to order RNJOP Receptacle	p20
Connector mounting - Generalities	p21
STARTOP	p23
STARTOP Plug : STA XXX XF XX X XXXX XX CXXX	p24
How to order STARTOP Plug	p24
STARTOP Receptacle : STARTOP Jam Nut Receptacle : STA XXX EX XX X XXXX XX CXXX	p25
How to order STARTOP Jam Nut Receptacle	p26
STARTOP Square Flange Receptacle : STA XXX VX XX X XXXX XX CXXX	p26
How to order STARTOP Square Flange Receptacle	p28
STARTOP Protective Caps	p28
POM	p29
Optical termini for standard mil-dtl-38 999 series III	p29
How to order POM	p29
Tactical cables technical information	p30

BUTT JOINT TECHNOLOGY / INSERT ARRANGEMENT

TVOP, LJTOP, RNJOP, STARTOP BUTT JOINT TECHNOLOGY KEY FEATURES

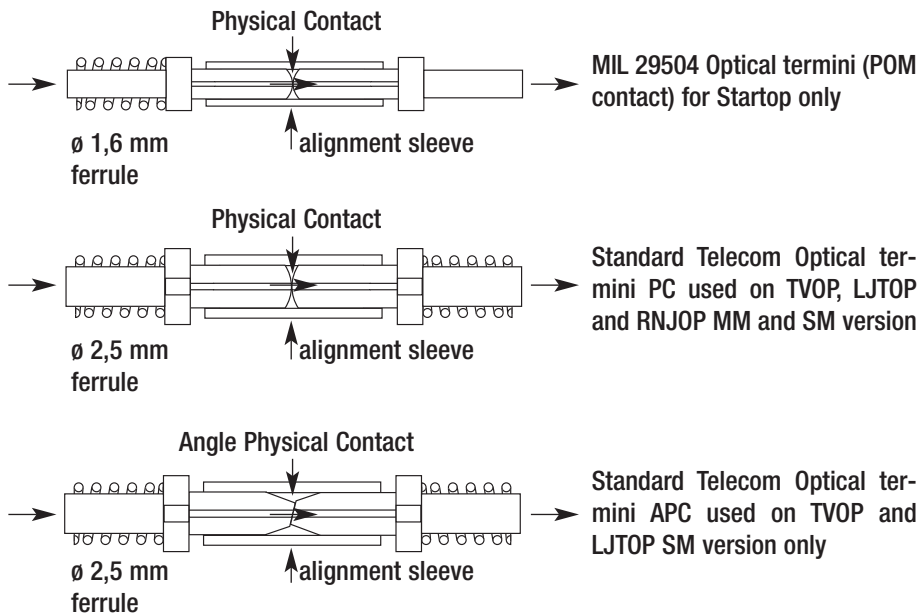

With AMPHENOL SOCAPEX's butt joint technology, fibers are permanently in physical contact, thanks to the spring loaded contact. The alignment sleeve guarantee the alignment for high reliability optical performance. These connector are highly resistant to vibrations, shocks, temperature.

INSERT ARRANGEMENT

For TVOP, LJTOP and RNJOP : standard ø2,5mm optical termini

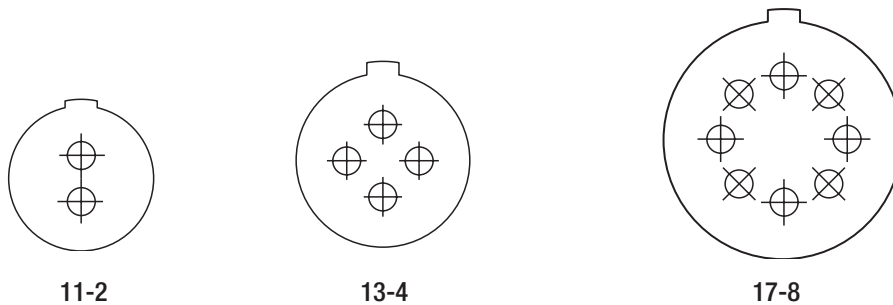

For Startop only : MIL 29504 Optical termini size 16



BUTT JOINT TECHNICAL SPECIFICATION

	TVOP	LJTOP	RNJOP	Startup
Max Number of Channel	8	8	8	8
Typical/Max Insertion Loss (per matted pair) Multimode 850 nm and 1310nm	0,5/0,8db EIA-455-34 method A			0,8/1,0db CEI 793-1-4
Typical/Max Insertion Loss (per matted pair) Singlemode 1310 nm and 1550nm	0,5db/0,8db EIA-455-34 method A			NA
Typical return Loss PC UU PC APC	-30db -45db -55db EIA-455-107			NA
Mating durability	500 cycles EIA-455-21			500 cycles NFC 93 422
Vibration	Sin. 10 to 2000HZ, 10g, peak to peak 1,52mm (0.06 inch), 3 directions Random 50 to 2000HZ, 10g ² /Hz, 3 directions MIL-STD-1344 method 2005			Sin. 5 to 55Hz, 2g NFC 93422, peak to peak 2mm, 2 directions CEI 68.2.6
Mechanical shock	30g, 11ms, sawtooth, 3 shocks per direction, 3 directions EIA-455-14 condition I			15g, 11ms, half sine, 2 shocks per direction, 2 directions 100g, 6ms, half sine, 2 shocks per direction, 2 directions CEI 68.2.7
Salt Spray	Nickel shell 48H Olive drab cadmium 500H MIL-STD-1344 method 1001 A			
Operating temperature	-46°C +85°C MIL 83 522			-40°C/+85°C CEI-68-2-1/CEI-68-2-2
Storage temperature	-62°C +85°C DOD-STD-1678 method 4020			
Water Immersion	IP67 CEI 529/EN 60529		NA	IP67 CEI 529/EN 60529
Tensile load	100daN MIL-STD-1344 method 2009	NA		80daN NFC 93 422



TVOP

TVOP



TVOP PLUG : TVOP 06

TVOP Plug with straight backshell and integrated metal clamp
TVOP 06 X S3 XX X XX X XXXX

TVOP Plug with straight backshell and integrated plastic clamp
TVOP 06 X S4 XX X XX X XXXX

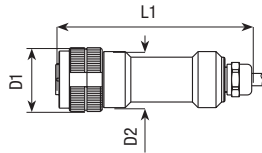

TVOP Plug with straight backshell and tightening jaws clamp
TVOP 06 X S5 XX X XX X XXXX

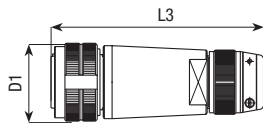

TVOP Plug with straight heatshrinkable backshell
TVOP 06 X H0 XX X XX X XXXX

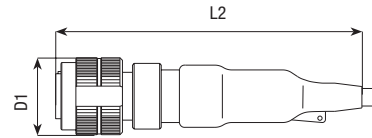

TVOP Plug with right angle heatshrinkable backshell
TVOP 06 X H9 XX X XX X XXXX

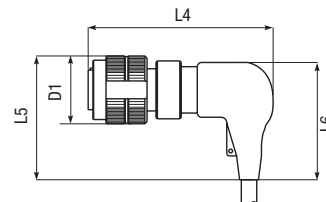

Overall dimensions

Shell Size		ØD1	ØD2	L1	L2	L3	L4	L5	L6
MIL.DTL. 38999 Series III	Amphenol Socapex	mm	mm	mm	mm	mm	mm	mm	mm
B	11	24.13	21	87.5	95.33	96.13	67.63	44.1	40.6
C	13	28.47	25	87.5	107.33	96.13	71.33	53.2	49.7
E	17	35.20	32	109.5	120.13	96.13	78.33	56.6	59.2

HOW TO ORDER TVOP PLUG

Series	TVOP	06	X	XX	XX	X	XX	X	XXXX
Shell type	06 : Plug								
Shell finish	F : Aluminium, electroless nickel plated W : Aluminium, olive drab cadmium plated B : Bronze								
Backshell	H0 : Straight angle heatshrinkable backshell without clamp H9 : Right angle heatshrinkable backshell without clamp S3 : Straight backshell for multiway cable with metal integrated clamp S4 : Straight backshell for multiway cable with plastic integrated clamp S5 : Straight backshell for multiway cable with tightening jaws clamp								
Shell size	Max Number of Channel								
11	2								
13	4								
17	8								
Type of ceramic ferrule	Ceramic ferrule inner diameter								
Multimode	7 : 127 µm								
Singlemode	6 : 126 µm								
Polarization :	N : for standard A, B, C, D, E : for special keying								
Cable diameter example	X055 : Ø 5,5 mm multiway cable								

TVOP RECEPTACLE : TVOP JAM NUT RECEPTACLE : TVOP 07

TVOP Jam Nut Receptacle Front Face

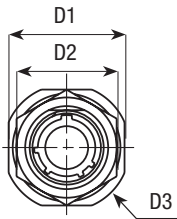

TVOP Jam Nut Receptacle with backshell for pigtails
TVOP 07 X R0 XX X XX X XXXX

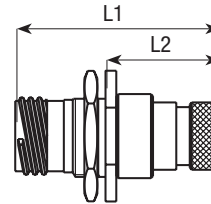

TVOP Jam Nut Receptacle with straight backshell and integrated metal clamp

TVOP 07 X S3 XX X XX X XXXX

TVOP Jam Nut Receptacle with straight backshell and integrated plastic clamp

TVOP 07 X S4 XX X XX X XXXX

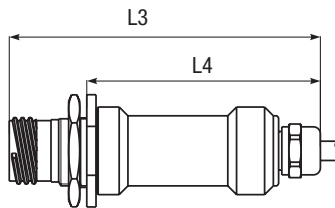

TVOP Jam Nut Receptacle with straight heatshrinkable backshell

TVOP 07 X H0 XX X XX X XXXX

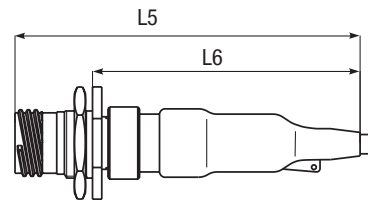

TVOP Jam Nut Receptacle with straight backshell and tightening jaws clamp

TVOP 07 X S5 XX X XX X XXXX

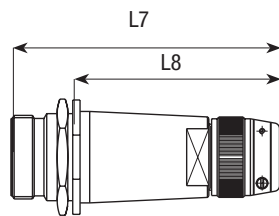

TVOP Jam Nut Receptacle with right angle heatshrinkable backshell

TVOP 07 X H9 XX X XX X XXXX

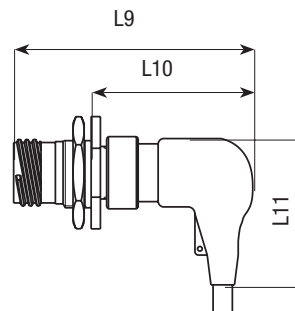

Panel Drilling for Jam Nut Receptacle

Panel Drilling
Jam nut receptacle
rear panel mounting

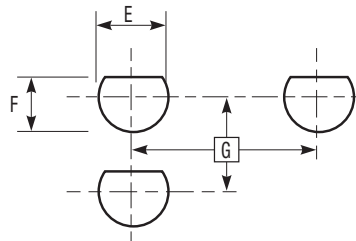

Overall dimensions

Shell Size																F		
MIL.DTL. 38999 Series III	Amphenol Socapex	D1	D2	øD3	L1	L2	L3	L4	L5	L6	L7	L8	L9	L10	L11	øE	+0	G
		mm	mm	mm	mm	mm	mm	mm	mm	mm	mm	mm	mm	mm	mm	mm	mm	mm
B	11	31.75	25.40	34.92	49.92	27.8	81.7	59.4	96.1	74	96.9	74.6	68.4	46.3	40.6	20.88	19.53	32.60
C	13	34.92	30.17	38.10	49.92	27.8	81.7	59.4	108.1	85.8	96.9	74.6	72.1	49.8	49.7	25.58	24.26	36.00
E	17	41.28	36.52	44.25	49.92	27.8	103.9	81.6	120.92	85.8	96.9	74.6	79.1	56.8	59.2	31.98	30.68	43.30



HOW TO ORDER TVOP JAM NUT RECEPTACLE

Series	TVOP	07	X	XX	XX	X	XX	X	XXXX
Shell type	_____								
07 : Jam nut receptacle	_____								
Shell finish	_____								
F : Aluminium, electroless nickel plated	_____								
W : Aluminium, olive drab cadmium plated	_____								
B : Bronze	_____								
Backshell	_____								
H0 : Straight heatshrinkable backshell without clamp	_____								
H9 : Right angle heatshrinkable backshell without clamp	_____								
R0 : Straight Backshell for pigtails	_____								
S3 : Straight backshell for multiway cable with metal integrated clamp	_____								
S4 : Straight backshell for multiway cable with plastic integrated clamp	_____								
S5 : Straight backshell for multiway cable with tightening jaws clamp	_____								
Shell size	Max Number of Channel	_____							
11	2	_____							
13	4	_____							
17	8	_____							
Type of ceramic ferrule	_____								
Multimode	Ceramic ferrule inner diameter	_____							
P : Physical Contact ferrule	7 : 127µm	_____							
Singlemode	Ceramic ferrule inner diameter	_____							
P : Physical Contact ferrule	6 : 126µm	_____							
A : Angle Physical Contact (high return loss)	_____								
Polarization	_____								
N : for standard	_____								
A, B, C, D, E : for special keying	_____								
Cable diameter	_____								
X055 : ø 5,5mm multiway cable (for backshell H0, H9, S3, S4, S5)	_____								
X015 : ø 1,5mm for pigtail (for backshell R0)	_____								

TVOP SQUARE FLANGE RECEPTACLE : TVOP 00

TVOP Square Flange Receptacle Front Face

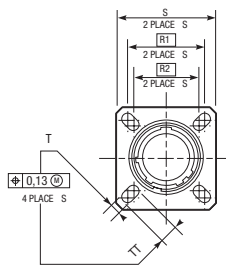

TVOP Square Flange Receptacle with straight backshell and integrated metal clamp

TVOP 00 X S3 XX X XX X XXXX

TVOP Square Flange Receptacle with straight backshell and integrated plastic clamp

TVOP 00 X S4 XX X XX X XXXX

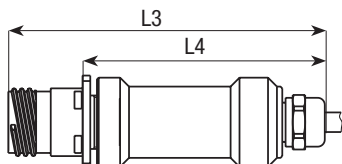

TVOP Square Flange Receptacle with backshell for pigtails

TVOP 00 X R0 XX X XX X XXXX

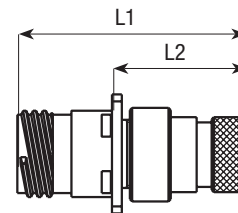

TVOP Square Flange Receptacle with straight heatshrinkable backshell

TVOP 00 X H0 XX X XX X XXXX

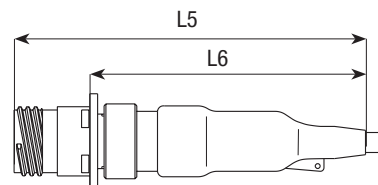

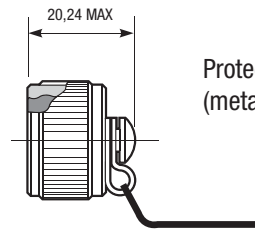

Protective cap for receptacle
(metallic chain or nylon cord)

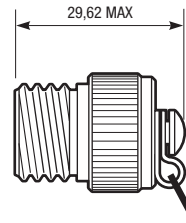

Protective cap for plug (metallic chain or nylon cord)

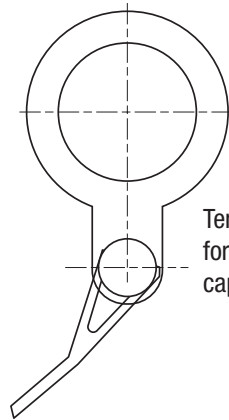

Termination of the chain or cord for jam nut receptacle protection caps (for shell type : 07)

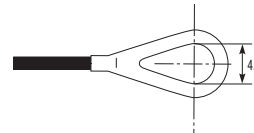

Termination of the cord for square flange receptacle protection caps (for shell type : 00)

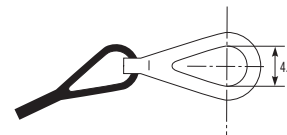

Termination of the chain for square flange receptacle and plug protection caps (for shell type : 00,06)

termination of the cord for plugs protection cap (for shell type : 06)

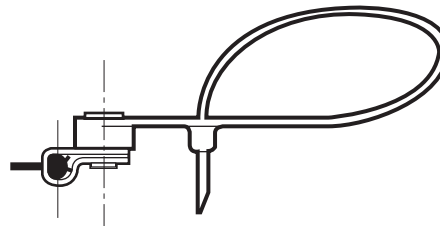

Cord length for plugs : 160mm
Cord length for receptacle : 105mm
Chain length for plugs : 127mm
Chain length for receptacle : 152mm

HOW TO ORDER TVOP DUST CAPS

CAP Series	B	XX	X	TV	X	XX
Protective cap type						
EC : For square flange receptacle						
ER : For jam nut receptacle						
F : For plug						
Wire type						
N : Nylon cord						
Blank : Metallic chain						
Shell finish						
B : Bronze						
F : Electroless nickel plated, aluminium version						
W : Olive drab cadmium plated, aluminium version						
Corresponding connector shell size :						
11, 13, 17						

TVOP patchcord

Requested information to order a TVOP patchcord

- Plug or Receptacle : define the P/N
- Type of fiber : 50/125, 62,5/125 or 9/125
- Patchcord length : ex. 10.5m
- Patchcord Configuration : plug/plug, plug/pigtail, plug/receptacle
receptacle/pigtail, receptacle/receptacle
- Drawing : please send us a drawing of your request
- Cable for plug : choose type of cable at the end of the catalogue



LJTOP

LJTOP



LJTOP PLUG : LJTOP 06

LJTOP Plug with straight backshell and integrated metal clamp
LJTOP 06 X S3 XX X XX X XXXX

LJTOP Plug with straight backshell and integrated plastic clamp
LJTOP 06 X S4 XX X XX X XXXX

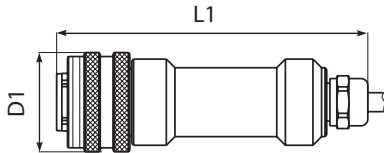

LJTOP Plug with straight heatshrinkable backshell
LJTOP 06 X H0 XX X XX X XXXX

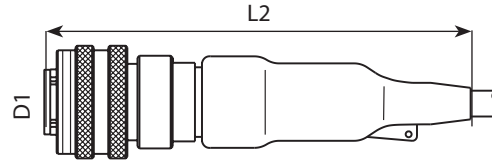

LJTOP Plug with right angle heatshrinkable backshell
LJTOP 06 X H9 XX X XX X XXXX

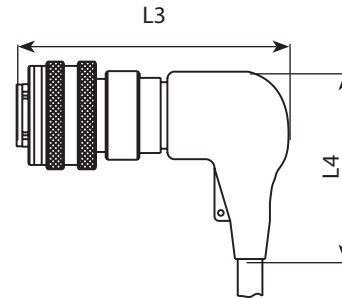

Overall dimensions

Shell Size		øD1	L1	L2	L3	L4
MIL.DTL. 38999 Series III	Amphenol Socapex	mm	mm	mm	mm	mm
B	11	24.5	92	95.33	67.33	40.6
C	13	28.8	92	107.33	71.33	49.7
E	17	35.30	114	120.33	78.33	59.2

HOW TO ORDER LJTOP PLUG

Series	LJTOP	06	X	XX	XX	X	XX	X	XXXX
Shell type	06 : Plug								
Shell finish	F : Aluminium, electroless nickel plated W : Aluminium, olive drab cadmium plated								
Backshell	H0 : Straight heatshrinkable backshell without clamp H9 : Right angle heatshrinkable backshell without clamp S3 : Straight backshell for multiway cable with metal integrated clamp S4 : Straight backshell for multiway cable with plastic integrated clamp								
Shell size	Max Number of Channel								
11	2								
13	4								
17	8								
Type of ceramic ferrule	Ceramic ferrule inner diameter								
Multimode	P : Physical Contact ferrule 7 : 127µm								
Singlemode	P : Physical Contact ferrule 6 : 126µm A : Angle Physical Contact (high return loss)								
Polarization	N : for standard A, B, C, D : for special keying								
Cable diameter example	X055 : ø 5,5mm multiway cable								

■ LJTOP RECEPTACLE : LJTOP JAM NUT RECEPTACLE : LJTOP 07

LJTOP Jam Nut Receptacle Front Face

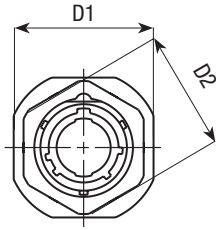

LJTOP Jam Nut Receptacle with straight backshell and integrated metal clamp

LJTOP 07 X S3 XX X XX X XXXX

LJTOP Jam Nut Receptacle with straight backshell and integrated plastic clamp

LJTOP 07 X S4 XX X XX X XXXX

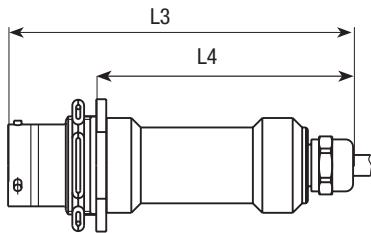

LJTOP Jam Nut Receptacle with backshell for pigtails

LJTOP 07 X R0 XX X XX X XXXX

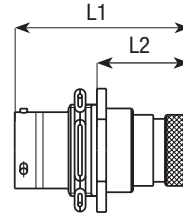

LJTOP Jam Nut Receptacle with straight heatshrinkable backshell

LJTOP 07 X H0 XX X XX X XXXX

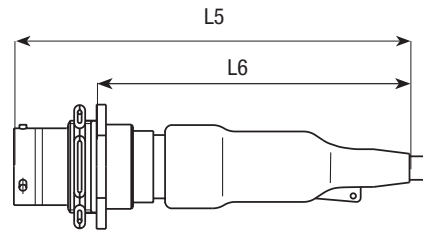

LJTOP Jam Nut Receptacle with right angle heatshrinkable backshell

LJTOP 07 X H9 XX X XX X XXXX

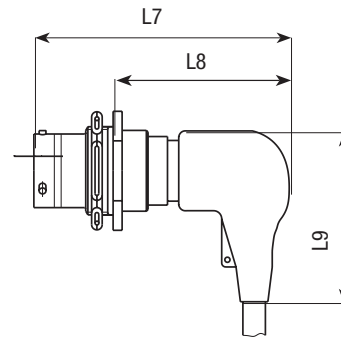

Panel Drilling for Jam Nut receptacle

Panel Drilling
Jam nut receptacle
rear panel mounting

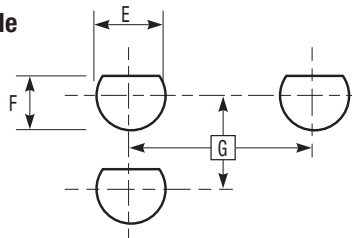

Overall dimensions

Shell Size		D1	D2	L1	L2	L3	L4	L5	L6	L7	L8	L9	øE	F	G
MIL.DTL. 38999 Series III	Amphenol Socapex	mm	mm	mm	mm	mm	mm	mm	mm	mm	mm	mm	Mini	+0 -0,25	Mini
B	11	31.74	25.4	49.49	26.25	90.4	67	95.99	72.75	70.99	47.75	40.6	20.88	19.53	32.60
C	13	34.91	30	49.49	26.25	90.4	67	95.99	72.75	75.29	52.85	49.7	25.58	24.26	36.00
E	17	41.26	37	49.49	26.25	110	86.8	95.99	72.75	82.29	59.05	50.7	31.98	30.68	43.30



HOW TO ORDER LJTOP JAM NUT RECEPTACLE

Series	LJTOP 07 X XX XX X XX X XXXX									
Shell type	07 : Jam nut receptacle									
Shell finish	F : Aluminium, electroless nickel plated W : Aluminium, olive drab cadmium plated									
Backshell	H0 : Straight heatshrinkable backshell without clamp H9 : Right angle heatshrinkable backshell without clamp R0 : Straight backshell for pigtails S3 : Straight backshell for multiway cable with metal integrated clamp S4 : Straight backshell for multiway cable with plastic integrated clamp									
Shell size	Max Number of Channel									
11	2									
13	4									
17	8									
Type of ceramic ferrule										
Multimode	Ceramic ferrule inner diameter									
P : Physical Contact ferrule	7 : 127µm									
Singlemode	Ceramic ferrule inner diameter									
P : Physical Contact ferrule	6 : 126µm									
A : Angle Physical Contact (high return loss)										
Polarization										
N : for standard										
A, B, C, D : for special keying										
Cable diameter										
X055 : ø 5,5mm multiway cable (for backshell H0, H9, S3, S4)										
X015 : ø 1,5mm for pigtail (for backshell R0)										

LJTOP SQUARE FLANGE RECEPTACLE : LJTOP 00

LJTOP Square Flange Receptacle Front Face

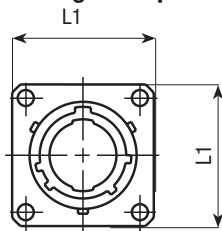

LJTOP Square Flange Receptacle with backshell for pigtails

LJTOP 00 X R0 XX X XX X XXXX

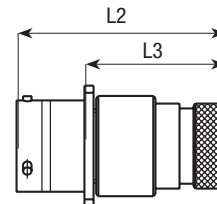

LJTOP Square Flange Receptacle with straight backshell and integrated metal clamp

LJTOP 00 X S3 XX X XX X XXXX

LJTOP Square Flange Receptacle with straight heatshrinkable backshell

LJTOP 00 X H0 XX X XX X XXXX

LJTOP Square Flange Receptacle with straight backshell and integrated plastic clamp

LJTOP 00 X S4 XX X XX X XXXX

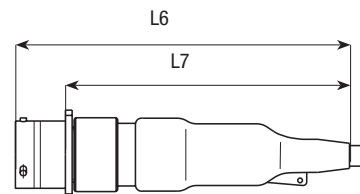
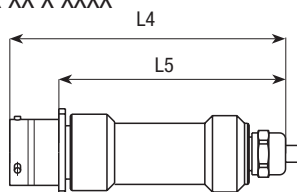

LJTOP

Panel Drilling for Square Flange receptacle

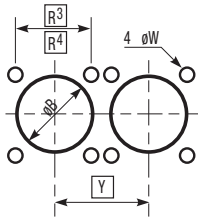

Square Flange receptacle rear panel mounting

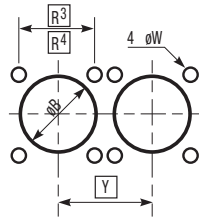

Square Flange receptacle front panel mounting

LJTOP Square Flange Receptacle with right angle heatshrinkable backshell

LJTOP 00 X H9 XX X XX X XXXX

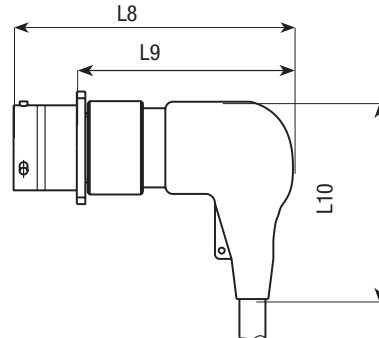

Overall dimensions

Shell Size																ϕW +0	Y	ϕB	ϕD
MIL.DTL. 38999 Series III	Amphenol Socapex	L1	L2	L3	L4	L5	L6	L7	L8	L9	L10	R ³	R ⁴	-0,25	mm	mm	mm		
B	11	26.19	48.83	32.78	90.4	74	95.33	79.28	70.33	54.28	40.6	20.62	18.26	3.25	27.00	20.22	15.88		
C	13	28.58	48.83	32.78	90.4	74	107.33	91.28	74.63	58.58	49.7	23.01	20.62	3.25	31.50	23.42	19.05		
E	17	33.32	48.83	32.78	110	94	120.33	104.28	81.63	65.58	59.2	26.97	24.61	3.25	38.00	30.96	25.81		

HOW TO ORDER LJTOP SQUARE FLANGE RECEPTACLE

16

Series	LJTOP	00	X	XX	XX	X	XX	X	XXXX				
Shell type	00 : Square Flange receptacle												
Shell finish	F : Aluminium, electroless nickel plated W : Aluminium, olive drab cadmium												
Backshell	H0 : Straight heatshrinkable backshell without clamp H9 : Right angle heatshrinkable backshell without clamp R0 : Straight backshell for pigtailed S3 : Straight backshell for multiway cable with metal integrated clamp S4 : Straight backshell for multiway cable with plastic integrated clamp												
Shell size	11	13	17	Max Number of Channel						2	4	8	
Type of ceramic ferrule	Multimode P : Physical Contact ferrule		Ceramic ferrule inner diameter 7 : 127µm							Singlemode P : Physical Contact ferrule A : Angle Physical Contact (high return loss)		Ceramic ferrule inner diameter 6 : 126µm	
Polarization	N : for standard A, B, C, D : for special keying												
Cable diameter	X055 : ø 5,5mm multiway cable (for backshell H0, H9, S3, S4) X015 : ø 1,5mm for pigtail (for backshell R0)												



■ LJTOP PROTECTIVE CAPS

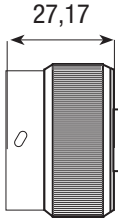

Protective cap for receptacle (metallic chain or nylon cord)

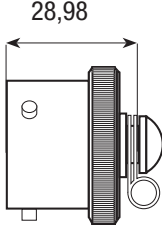

Protective cap for plug (metallic chain or nylon cord)

■ HOW TO ORDER LJTOP DUST CAPS

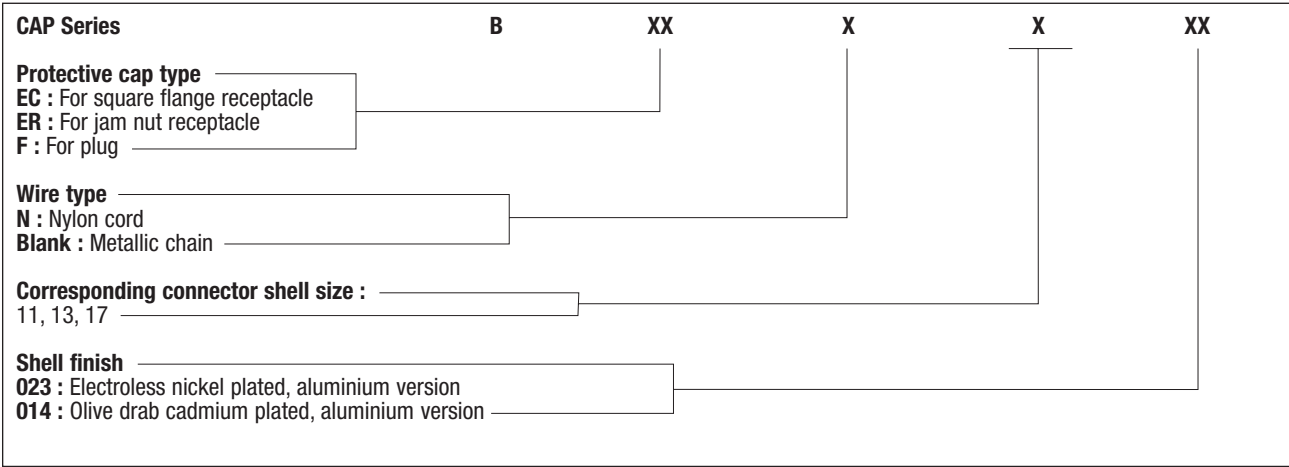

LJTOP patchcord

Requested information to order a LJTOP patchcord

- Plug or Receptacle : define the P/N
- Type of fiber : 50/125, 62,5/125 or 9/125
- Patchcord length : ex. 10.5m
- Patchcord Configuration : plug/plug, plug/pigtail, plug/receptacle
receptacle/pigtail, receptacle/receptacle
- Drawing : please send us a drawing of your request



RNJOP

RNJOP



RNJOP PLUG* : RNJOP 06

RNJOP female straight plug

RNJOP 06 X XX XX X XX X XXXX

Product supplied
with rear
accessories

Product supplied
without rear
accessories

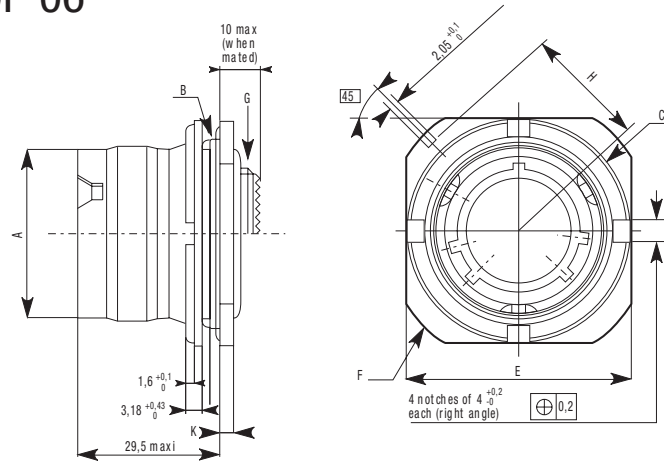

*: Only RNJOP specific dimensions are mentioned in these figures
All dimensions which are not mentioned meet the Mil-C-38999 Series I Standard.

Overall dimensions

Shell size	Diameter A +0.03/-0.13 mm	Thread B Class 2A (inches)	C Max (mm)	E +/-0.41 (mm)	Diameter F Max. (mm)	Thread G Class 2A UNEF	H +/-0.2 (mm)	K +0.28/-0.25 (mm)
11	23	1.0000-20 UNEF	32.10	32.16	38.10	0.5625-24	16.92	2.77
13	26.80	1.1250-18 UNEF	35.25	36.34	41.27	0.6875-24	18.51	2.77
17	33.22	1.375-18 UNEF	41.60	41.69	49.23	0.9375-20	22.67	2.77

HOW TO ORDER RNJOP PLUG

Series	RNJOP	06	X	XX	XX	X	XX	X	XXXX
Shell type	_____								
06 : Female straight plug	_____								
Shell finish	_____								
F : Aluminium, electroless nickel plated	_____								
W : Aluminium, olive drab cadmium plated	_____								
Backshell	_____								
NO : Without backshell	_____								
RO : Straight backshell for pigtails	_____								
Shell size	Max Number of Channel	_____							
11	2	_____							
13	4	_____							
17	8	_____							
Type of ceramic ferrule	_____								
Multimode	_____								
P : Physical Contact ferrule	Ceramic ferrule inner diameter	_____							
	7 : 127µm	_____							
Polarization	_____								
N : for normal position only	_____								
Cable diameter example	_____								
X015 : ø 1,5mm	_____								
XXXX : cable defined by the customer	_____								

RNJOP JAM NUT RECEPTACLE * : RNJOP 07

RNJOP Male Jam Nut Receptacle

RNJOP 07 X 00 XX X XX X XXXX

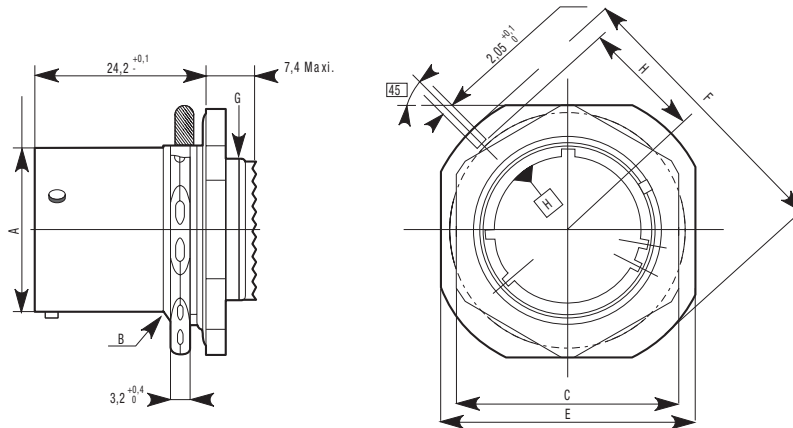

*: Only RNJOP specific dimensions are mentioned in these figures
All dimensions which are not mentioned meet the Mil-C-38999 Series I Standard.

Overall dimensions

Shell size	Diameter A Max (mm)	Thread B Class 2A (inches)	C Max (mm)	E +/-0.41 (mm)	Diameter F +/-0.41 (mm)	Thread G Class 2A UNEF	H +/-0.25 (mm)
11	17.78	0.8125-50 UNEF	25.80	31.75	35.20	0.5625-24	15.33
13	21.59	1.0000-20 UNEF	30	34.92	38.38	0.6875-24	16.92
17	27.94	1.2500-18 UNEF	37	41.27	44.73	0.9375-20	20.10

HOW TO ORDER RNJOP RECEPTACLE

Series	RNJOP	07	X	XX	XX X	XX	X	XXXX
Shell type	_____							
07 : Male Jam Nut Receptacle	_____							
Shell finish	_____							
F : Aluminium, electroless nickel plated	_____							
W : Aluminium, olive drab cadmium plated	_____							
Backshell	_____							
NO : Without backshell	_____							
RO : Straight backshell for pigtails	_____							
Shell size	Max Number of Channel	_____						_____
11	2	_____						_____
13	4	_____						_____
17	8	_____						_____
Type of ceramic ferrule	_____							
Multimode	_____							
P : Physical Contact ferrule	Ceramic ferrule inner diameter	_____						_____
	7 : 127µm	_____						_____
Polarization	_____							
N : for normal position only	_____							
Cable diameter example	_____							
X015 : ø 1,5mm	_____							
XXXX : cable define by the customer	_____							

CONNECTOR MOUNTING - GENERALITIES

- 36mm ± 0.5 dimension between flanges is compulsory to secure the technical performances on mated position.
- A guiding system adjust the rack position independently of the connectors.
- No mechanical stress is applied to the plug rear and the optical cables.

Alignment tolerances during mating

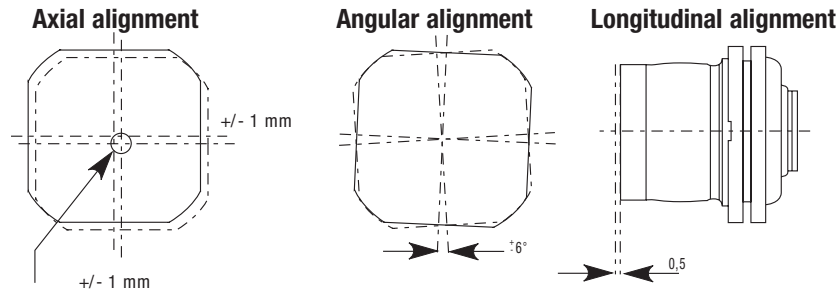

RNJOP connectors allow to integrate the design tolerances between the moving and fixed unit, up to the limits indicated on the drawing.

Mated connectors (dimensions in mm)

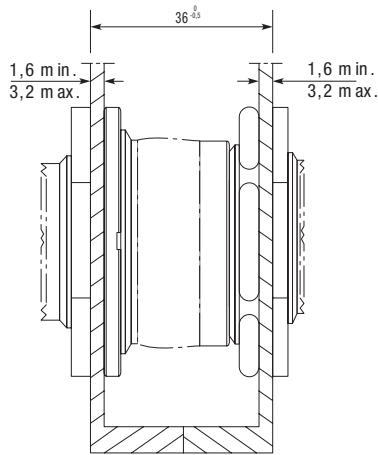

Overall dimensions

Shell size		K min. (mm)	W (mm)	Diameter X +0.1-0 (mm)
Plug	Receptacle			
-	11	11.69	11.69	20.88
11	13	32.60	12.81	25.58
13	-	36	13.94	28.80
-	17	39.60	15.06	31.98
17	-	43.30	16.88	35.15

Panel drilling (dimensions in mm)

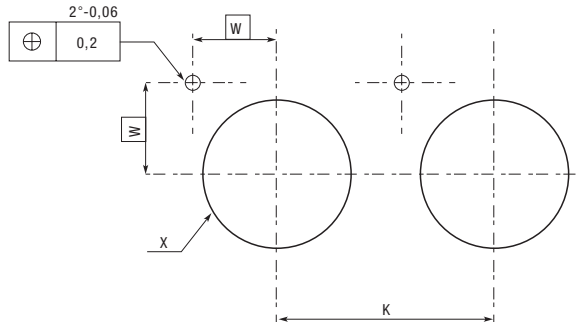

RNJOP patchcord

Requested information to order a RNJOP patchcord

Plug or Receptacle	: define the P/N
Type of fiber	: 50/125, 62,5/125
Patchcord length	: ex. 10.5m
Patchcord Configuration	: plug/plug, plug/pigtail, plug/receptacle receptacle/pigtail, receptacle/receptacle
Drawing	: please send us a drawing of your request



STARTOP



STARTOP

STARTOP PLUG : STA XXX XF XX X XXXX XX CXXX

Startup Plug with straight backshell and integrated metal clamp
 STA 00P XF XX X XXXX XX C XXX

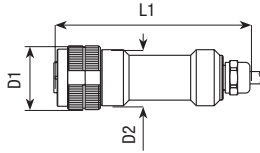

Startup Plug with straight heatshrinkable backshell
 STA 00P XF XX X XXXX XX C XXX

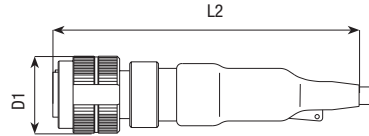

Startup Plug with straight backshell and tightening jaws clamp
 STA 00S XF XX X XXXX XX C XXX

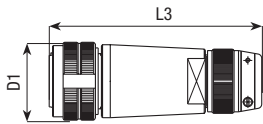

Startup Plug with right angle heatshrinkable backshell
 STA 90T XF XX X XXXX XX C XXX

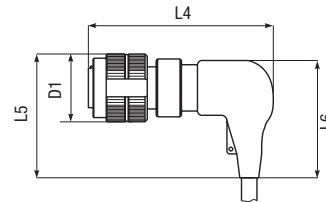

Overall dimensions

Shell Size		D1	D2	L1	L2	L3	L4	L5	L6
MIL.DTL. 38999 Series III	Amphenol Socapex	mm	mm	mm	mm	mm	mm	mm	mm
B	11	24.13	21	87.5	95.33	96.13	67.63	44.1	40.6
C	13	28.47	25	87.5	107.33	96.13	71.33	53.2	49.7
D	15	31.72	28	109.5	107.33	96.16	71.33	54.9	50.7
E	17	35.20	32	109.5	120.13	96.13	78.33	56.6	59.2

HOW TO ORDER STARTOP PLUG

Series	STA	XX	X	XF	XX	X	XXXX	XX	CXXX
Angle type	_____		_____	_____	_____	_____	_____	_____	_____
00 : Straight	_____		_____	_____	_____	_____	_____	_____	_____
90 : Right angle (only for heatshrinkable backshell)	_____		_____	_____	_____	_____	_____	_____	_____
Backshell	_____		_____	_____	_____	_____	_____	_____	_____
S : Straight backshell for multiway cable with tightening jaws clamp	_____		_____	_____	_____	_____	_____	_____	_____
P : Straight backshell for multiway cable with metal integrated clamp	_____		_____	_____	_____	_____	_____	_____	_____
T : Heatshrinkable backshell without clamp	_____		_____	_____	_____	_____	_____	_____	_____
Shell type	_____		_____	_____	_____	_____	_____	_____	_____
MF : Male plug	_____		_____	_____	_____	_____	_____	_____	_____
FF : Female plug	_____		_____	_____	_____	_____	_____	_____	_____
Shell size	_____		_____	_____	_____	_____	_____	_____	_____
11 (max. number of channels 2)	_____		_____	_____	_____	_____	_____	_____	_____
13 (max. number of channels 4)	_____		_____	_____	_____	_____	_____	_____	_____
15 (max. number of channels 5)	_____		_____	_____	_____	_____	_____	_____	_____
17 (max. number of channels 8)	_____		_____	_____	_____	_____	_____	_____	_____
Polarization	_____		_____	_____	_____	_____	_____	_____	_____
N : for standard	_____		_____	_____	_____	_____	_____	_____	_____
A, B, C, D, E : for special keying	_____		_____	_____	_____	_____	_____	_____	_____
Diameter cable	_____		_____	_____	_____	_____	_____	_____	_____
055 : ø 5,5mm	_____		_____	_____	_____	_____	_____	_____	_____
110 : ø 11mm	_____		_____	_____	_____	_____	_____	_____	_____
Shell finish	_____		_____	_____	_____	_____	_____	_____	_____
RW : Aluminium, olive drab cadmium plated	_____		_____	_____	_____	_____	_____	_____	_____
RB : Bronze	_____		_____	_____	_____	_____	_____	_____	_____
Optical termini Multimode	_____		_____	_____	_____	_____	_____	_____	_____
O : Without optical termini	_____		_____	_____	_____	_____	_____	_____	_____
XA1 : X POM contact for fiber MM 50/125 or 62,5/125	_____		_____	_____	_____	_____	_____	_____	_____
XC1 : X POM contact for fiber MM 100/140	_____		_____	_____	_____	_____	_____	_____	_____



STARTOP RECEPTACLE :

STARTOP JAM NUT RECEPTACLE : STA XXX EX XX X XXXX XX CXXX

Startop Jam Nut Receptacle Front Face

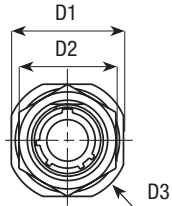

Startop Jam Nut Receptacle with backshell for pigtails
STA 00 R EX XX X XXXX XX CXXX

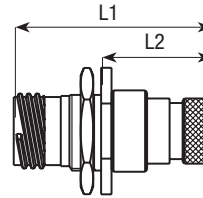

Startop Jam Nut Receptacle with straight backshell and integrated metal clamp

STA 00 P EX XX X XXXX XX CXXX

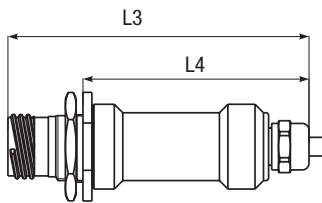

Startop Jam Nut Receptacle with straight heatshrinkable backshell

STA 00 T EX XX X XXXX XX CXXX

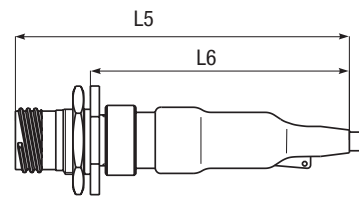

Startop Jam Nut Receptacle with straight backshell and tightening jaws clamp

STA 00 S EX XX X XXXX XX CXXX

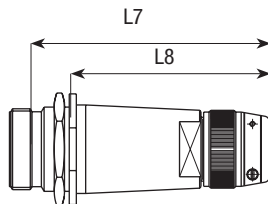

Startop Jam Nut Receptacle with right angle heatshrinkable backshell

STA 90 T EX XX X XXXX XX CXXX

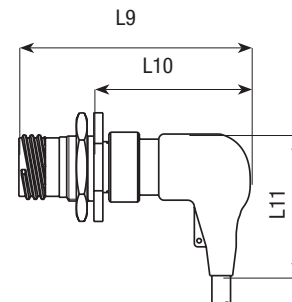

Panel Drilling for Jam Nut receptacle

Panel Drilling
Jam nut receptacle
rear panel mounting

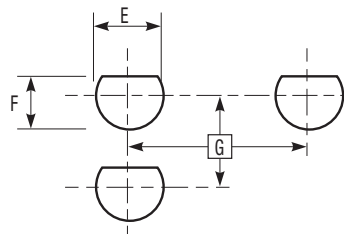

Overall dimensions

Shell Size		D1	D2	øD3	L1	L2	L3	L4	L5	L6	L7	L8	L9	L10	L11	øE Mini	F +0 -0,25	G Mini
MIL.DTL. 38999 Series III	Amphenol Socapex	mm	mm	mm	mm	mm	mm	mm	mm	mm	mm	mm	mm	mm	mm	mm	mm	
B	11	31.75	25.40	34.92	49.92	27.6	81.7	59.6	96.1	74.0	96.9	74.6	68.4	46.3	40.6	20.88	19.53	32.60
C	13	34.92	30.17	38.10	49.92	27.6	81.7	59.4	108.1	85.8	96.9	74.6	72.1	49.8	49.7	25.58	24.26	36.00
D	15	38.10	33.32	41.27	49.92	27.6	103.9	59.6	108.12	85.8	96.9	74.6	72.1	49.8	50.7	28.80	27.53	39.60
E	17	41.28	36.52	44.25	49.92	27.6	103.9	81.6	120.92	98.6	96.9	74.6	79.1	56.8	59.2	31.98	30.68	43.30

HOW TO ORDER STARTOP JAM NUT RECEPTACLE

Series	STA	XX	X	EX	XX	X	XXXX	XX	CXXX
Angle type									
00 : Straight									
90 : Right angle (only for heatshrinkable backshell)									
Backshell									
S : Straight backshell for multiway cable with tightening jaws clamp									
P : Straight backshell for multiway cable with metal integrated clamp									
T : Heatshrinkable backshell without clamp									
R : Straight backshell for pigtail									
Shell type									
EF : Female jam nut receptacle									
EM : Male jam nut receptacle									
Shell size									
11 (max. number of channels 2)									
13 (max. number of channels 4)									
15 (max. number of channels 5)									
17 (max. number of channels 8)									
Polarization									
N : for standard									
A, B, C, D, E : for special keying									
Diameter cable									
015 : \varnothing 1,5mm									
055 : \varnothing 5,5mm multiway cable									
110 : \varnothing 110mm multiway cable									
Shell finish									
RW : Aluminium, olive drab cadmium plated									
RB : Bronze									
Optical termini Multimode									
0 : Without optical termini									
XA1 : X POM contact for fiber MM 50/125 or 62,5/125									
XC1 : X POM contact for fiber MM 100/140									

STARTOP SQUARE FLANGE RECEPTACLE : STA XXX VX XX X XXXX XX CXXX

Startop Square Flange Receptacle Front Face

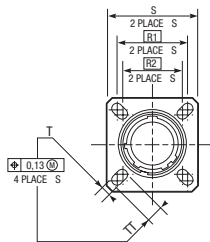

Startop Square Flange Receptacle with backshell for pigtails

STA 00 R VX XX X XXXX XX CXXX

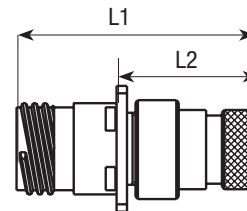

Startop Square Flange Receptacle with straight backshell and integrated metal clamp

STA 00 P VX XX X XXXX XX CXXX

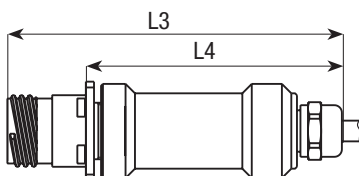

Startop Square Flange Receptacle with straight heatshrinkable backshell

STA 00 T VX XX X XXXX XX CXXX

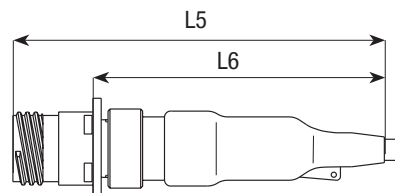

Startop Square Flange Receptacle with straight backshell and tightening jaws clamp

STA 00 S VX XX X XXXX XX CXXX

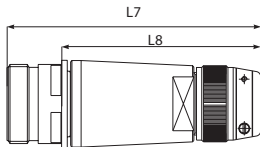

Startop Square Flange Receptacle with right angle heatshrinkable backshell

STA 90 T VX XX X XXXX XX CXXX

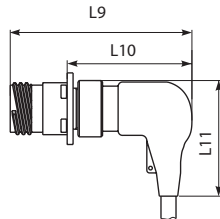

Panel Drilling for Square Flange receptacle

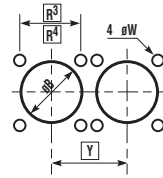

Square Flange receptacle rear panel mounting

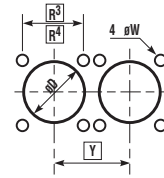

Square Flange receptacle front panel mounting

Overall dimensions

Shell Size		T		TT																	øW							
MIL.DTL. 38999	Amphenol	S	+0,20	+0,20	L1	L2	L3	L4	L5	L6	L7	L8	L9	L10	L11	R ³	R ⁴	-0,25	Y	øB	øD	R ¹	R ²					
Series III	Socapex	mm	mm	mm	mm	mm	mm	mm	mm	mm	mm	mm	mm	mm	mm	mm	mm	mm	mm	mm	mm	mm	mm					
B	11	26.19	3.25	4.93	49.77	28.94	81.7	59.6	95.97	75.14	96.77	75.94	68.27	47.44	40.6	20.62	18.26	3.25	27.00	20.22	15.88	20.62	18.26					
C	13	28.58	3.25	4.93	49.77	28.94	81.7	59.6	107.97	87.14	96.77	75.94	71.97	51.14	49.7	23.01	20.62	3.25	31.50	23.42	19.05	23.01	20.62					
D	15	30.96	3.25	4.93	49.77	28.94	103.9	80.16	107.97	87.14	96.77	75.94	71.97	51.14	50.7	24.61	23.01	3.25	34.50	26.59	23.01	24.61	23.01					
E	17	33.32	3.25	4.93	49.77	28.94	103.9	81.6	120.77	99.94	96.77	75.94	78.97	58.14	59.2	26.97	24.61	3.25	38.00	30.96	25.81	26.97	24.61					

HOW TO ORDER STARTOP SQUARE FLANGE RECEPTACLE

Series	STA	XX	X	VX	XX	X	XXXX	XX	CXXX
Angle type	_____								
00 : Straight	_____								
90 : Right angle (only for heatshrinkable backshell)	_____								
Backshell	_____								
S : Straight backshell for multiway cable with tightening jaws clamp	_____								
P : Straight backshell for multiway cable with metal integrated clamp	_____								
T : Heatshrinkable backshell without clamp	_____								
R : Straight backshell for pigtail	_____								
Shell type	_____								
VF : Female square flange receptacle	_____								
VM : Male square flange receptacle	_____								
Shell size	_____								
11 (max. number of channels 2)	_____								
13 (max. number of channels 4)	_____								
15 (max. number of channels 5)	_____								
17 (max. number of channels 8)	_____								
Polarization	_____								
N : for standard	_____								
A, B, C, D, E : for special keying	_____								
Diameter cable	_____								
015 : ø 1,5mm (only for backshell for pigtail)	_____								
055 : ø 5,5mm multiway cable	_____								
110 : ø 110mm multiway cable	_____								
Shell finish	_____								
RW : Aluminium, olive drab cadmium plated	_____								
RB : Bronze	_____								
Optical termini Multimode	_____								
O : Without optical termini	_____								
XA1 : X POM contact for fiber MM 50/125 or 62,5/125	_____								
XC1 : X POM contact for fiber MM 100/140	_____								

STARTOP PROTECTIVE CAPS

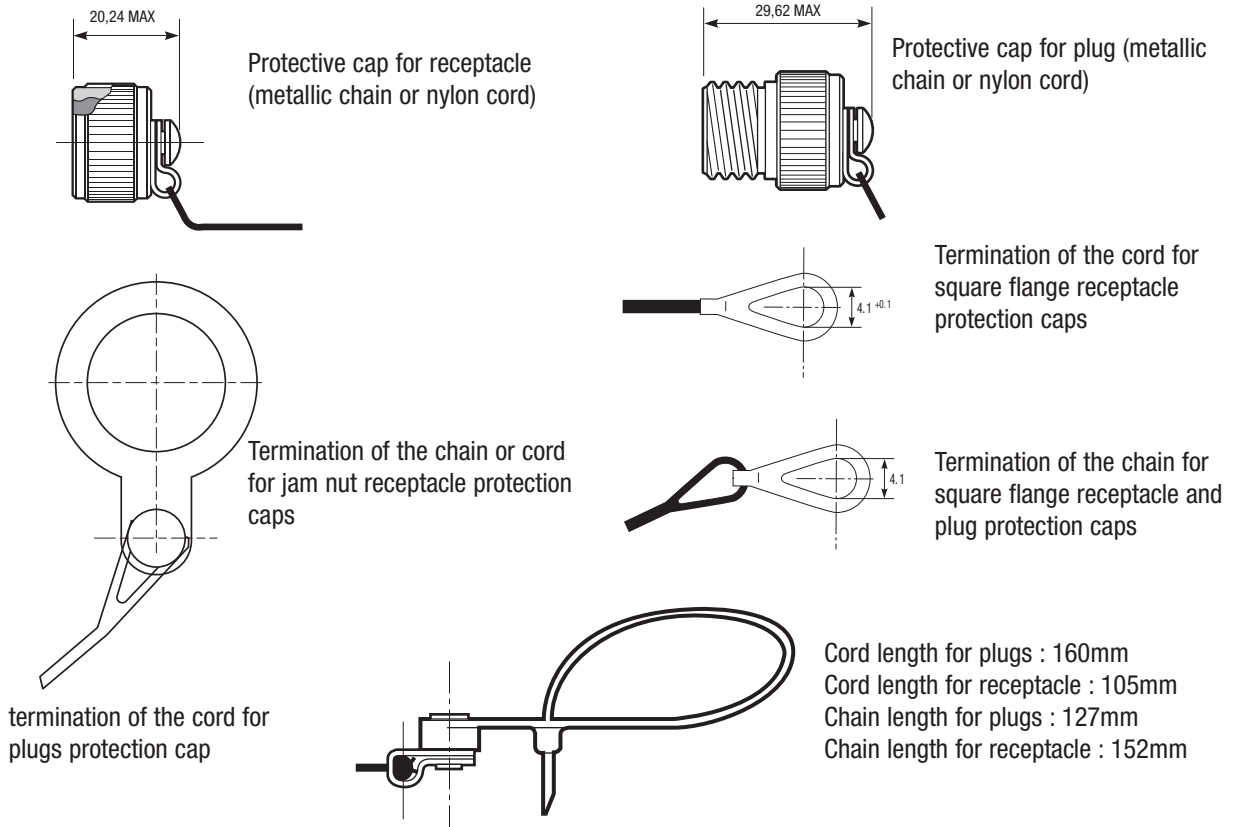

HOW TO ORDER STARTOP DUST CAPS

CAP Series	B	XX	X	TV	X	XX
Protective cap type EC : For square flange receptacle ER : For jam nut receptacle F : For plug						
Wire type N : Nylon cord Blank : Metallic chain						
Shell finish B : Bronze W : Olive drab cadmium plated, aluminium version						
Corresponding connector shell size : 11, 13, 15, 17						

STARTOP patchcord

Requested information to order a Startop patchcord

Plug or Receptacle	: define the P/N
Type of fiber	: 50/125, 62,5/125
Patchcord length	: ex. 10.5m
Patchcord Configuration	: plug/plug, plug/pigtail, plug/receptacle receptacle/pigtail, receptacle/receptacle
Drawing	: please send us a drawing of your request



OPTICAL TERMINI FOR STANDARD MIL-DTL-38 999 SERIES III



Technical Specifications

- Fibers: 50/125 and 62,5/125 (other: contact us)
- Typical Insertion Loss : 0,8 dB
- Maximum Insertion loss : 1,0db
- Durability : < 0.1 dB change after 250 mating/unmating cycles
- Cable retention by crimping : > 10 daN for 1,5 mm cable
- Operating Temperature : -40°C, +85°C
- Contacts in accordance with the MIL-T 29504/4 and /5 standards
- Materials :
 - Metal contact body
 - \varnothing 1,6 mm ceramic ferrule
- Metal alignment sleeve
- Return spring assuring the physical contact of the optical

POM Pin Contact
POM MD 16 C XX 15 XX

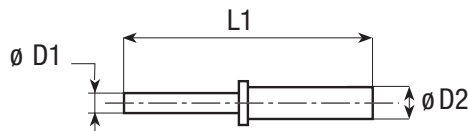

POM Socket Contact
POM FD 16 C XX 15 XX

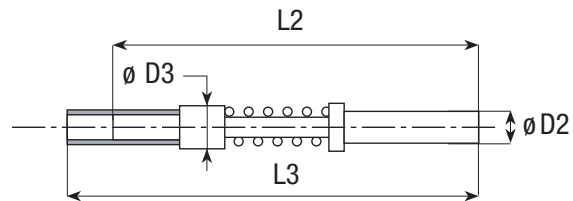

Overall dimensions

	\varnothing D1 (mm)	\varnothing D2 (mm)	\varnothing D3 (mm)	L1 (mm)	L2 (mm)	L3 (mm)
contact POM	1.6	2.6	2.9	25	30.9	33.3

HOW TO ORDER POM

Series	POM	XX	16	C	XX	15	XX
Contact type	MD : pin contact FD : Socket contact						
Size Contact	16 : Size 16 contact						
Type of ceramic	C : Ceramic ferrule						
Fiber type	A1 : 50/125 μ m or 62,5/125 μ m C1 : 100/140 μ m						
Diameter Cable	15 : \varnothing 1,5mm (only for backshell for pigtail) others diameters available : consult us						
Packaging	C0 : Volume packaging U : Individual Unit Packaging						

Tactical cables technical information

Company		OCC				NEXANS				SPECTRA STRIP	BRUGG		
Number of fibers		2	4	6	8	1	2-4	6	8	1 - 2 - 4 - 6 - 8	1	2	4
Cable diameter mm (in)		5 (0,2)	5,5 (0,22)	6,0 (0,24)	6,5 (0,26)	6 (0,24)	5,4 (0,21)	6,1 (0,24)	6,3 (0,25)	5,5 (0,22)	3,4 (0,13)	3,8 (0,15)	3,8 (0,15)
Cable weight kg/km (lb/1,000ft)		23 (15)	28 (19)	28 (19)	38 (26)	26 (18)	25 (17)	32 (22)	35 (24)	(2-4 core typically) 25 (17)	18 (12)	25 (17)	26 (17)
Reinforcing protection		aramid yarns				aramid yarns				aramid yarns	stainless-steel wires		
Outside jacket		polyurethan				polyurethan				spectraloy	polyamid		
Fiber minimum bandwidth	Multimode 850nm (MHz/km)	200 (62,5/125)				500 (50/125) 200 (62,5/125)				200 (50/125) 400 (62,5/125)	500		
	Multimode 1300nm (MHz/km)	500 (62,5/125)				800 (50/125) 500 (62,5/125)				400 (50/125) 600 (62,5/125)	800		
	Single mode 1310nm (GHz/km)	-				-				3,5	3,5		
	Single mode 1550nm (GHz/km)	-				-				18	18		
Fiber maximal attenuation	Multimode 850nm (dB/km)	3 (62,5/125)				3,5				3,5	2,7		
	Multimode 1300nm (dB/km)	1 (62,5/125)				1,5				1,5	0,8		
	Single mode 1310nm (dB/km)	-				0,42				0,45	0,36		
	Single mode 1550nm (dB/km)	-				0,28				0,3	0,25		
Temperature range	Storage	-70°C / +85°C (-94°F / +185°F)				-40°C / +70°C (-40°F / +158°F)				-60°C / +85°C (-76°F / +185°F)	-60°C / +85°C (-76°F / +185°F)		
	Operating	-55°C / +85°C (-67°F / +185°F)				-40°C / +70°C (-40°F / +158°F)				-55°C / +85°C (-67°F / +185°F)	-55°C / +85°C (-67°F / +185°F)		
Minimum bending radius mm (in)		8 X OD cable				60 (2,36)	50 (1,97)			10 X OD cable	30 (1,18)	35 (1,38)	35 (1,38)
Maximum tensile strength	Short term N (lbs.f)	1800 (405)	1800 (405)	1800 (405)	1800 (405)	(IEC 794 1E1) 2200 (495)				(2-4 core typically) (60- 1 part.3 cl.15.1) 2000 (450)	1000 (225)	2500 (562)	1600 (360)
	Operating N (lbs.f)	600 (135)	600 (135)	600 (135)	600 (135)	1300 (292)				(2-4 core typically) 2600	750 (169)	1800 (405)	1100 (247)
Crush resistance N/cm (lbs/in)		(EIA 455 41) 440 (251)				(IEC 794 1E3) 300 (171)				(2-4 core typically) (IEC 60794-1-1 &2) 1200 (685)	2500 (1428)	1200 (685)	1000 (571)
Impact resistance (1J impact)		(EIA 455 25) 200				(IEC 794 1E4) 100				100 min	100 min		
Torsion/torque		(TIA/EIA-455-104) 2000 cycles				(IEC 794 1E8) 30000 cycles				(2-4 core typically) (IEC 60794-1-1) 1000 cycles	10000 min	7000 min	7000 min

Technical information given by the supplier

Tactical cables with aramid yarn reinforcing protection

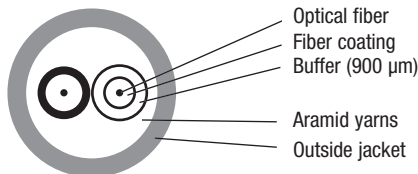

Tactical cable with stainless steel wires reinforcing protection

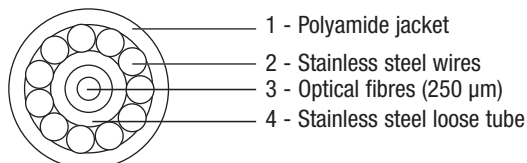



NORTH AMERICA

AMPHENOL Pcd, Inc.

2 Technology Drive
Peabody, MA 01960
Telephone: 1-978-532-8800
Fax: 1-978-532-6800

AMPHENOL AEROSPACE OPERATIONS AMPHENOL INDUSTRIAL OPERATIONS

40-60 Delaware Street
Sidney, New York 13838-1395 - USA
Telephone: 1-607-563-5011
Fax: 1-607-563-5157

AMPHENOL BACKPLANE SYSTEMS

18 Celina Avenue
Nashua, New Hampshire 03063 - USA
Telephone: 1-603-883-5100
Fax: 1-603-883-0171

AMPHENOL CANADA CORPORATION

20 Melford Drive - Scarborough, Ontario M1B 2X6
Canada
Telephone: 1-416-291-4401 Fax: 1-416-292-0647
1870 boul. des Sources, Suite 204
Pointe Claire, Quebec H9R 5N4 - Canada
Telephone: 1-514-630-7242 ext. 225
Fax: 1-514-630-7697

AMPHENOL FIBER OPTIC PRODUCTS- RICHARDSON OPERATION

1778 North Plano Road, Suite 212
Richardson, Texas 75081
Telephone: 1-972-744-9801
Fax: 1-972-744-9022

AMPHENOL FSI

1300 Central Expwy N, Suite 100
Allen, TX 75013 U.S.A.
Toll-Free: 800-472-4225 - Fax: 214-547-9344
info@fibersystems.com

EUROPE

AMPHENOL SOCAPEX

MIL-AERO & INDUSTRIAL Business Unit
948 Promenade de l'Arve - B. P. 29
74311 Thyez Cedex - France
Telephone: 33-4-5089-2800
Fax: 33-4-5096-1941

AMPHENOL LIMITED WHITSTABLE

Thanet Way, Whitstable - Kent, CT5 3JF
United Kingdom
Telephone: 44-1227-773-200
Fax: 44-1227-276-571

AMPHENOL LIMITED NOTTINGHAM

Unit D1 Crossgate Drive, Queens Drive Industrial
Estate - NG2 1LW - Nottingham - United Kingdom
Telephone: 44-1159-866-200
Fax: 44-1159-866-212

AMPHENOL AIR LB GmbH

Am Kleinbahnhof 4 - 66740 Saarlouis Germany
Telephone: 49-6831-981-00
Fax: 49-6831-981-030

AMPHENOL ITALIA

Via Barbaiana n. 5, 20020 Lainate - Milano - Italy
Telephone: 39-293-55-03-71
Fax: 39-348-361-7249

AMPHENOL IBERICA

C/Calderon de la barca, 3 4A, 28 100 Alcobendas,
Madrid - Spain
Telephone: 34-91-654-83-52
Fax: 34-91-640-73-07

AMPHENOL SCANDINAVIA

Snosvängen 14 13466 Ingarö - Sweden
Telephone: 46-8-571-423-90
Fax: 46-8-571-423-89

AMPHENOL BENELUX

Zadelmaker 121 NL-2401 PD Alphen aan den Rijn
The Netherlands
Telephone: 31-172-444-903
Fax: 31-172-240-254

AMPHENOL CENTRAL EUROPE

Topolowa 13, 41 600 Swietochlowice - Poland
Telephone: 48-32-3484-201 - Fax: 48-32-3484-202

AMPHENOL EUROPEAN

SALES OPERATIONS

Hoofdveste 19 - 3992 DH Houten - The Netherlands
Telephone: 31-30-635-8000 - Fax: 31-30-637-7034

ASIA

CHINA (FOP)

3rd Floor, The 4th Ind. District of Ind.
Headquarters Dong Keng Road, Gong Ming Town
Shenzen 518132, Guangdong Province - PR China
Telephone: 86-755-717-7945
Fax: 86-755-717-7622

AMPHENOL TAIWAN CORPORATION

No. 116, Lane 956, Zhong Shan Road
Taoyuan City, R. O. C., 330 - Taiwan
Telephone: 886-3-379-5677
Fax: 886-3-360-7259 Sales/CS/Eng./QA/MIS

AMPHENOL EAST ASIA LIMITED

2201 Railway Plaza, 39 Chatham Road South
Tsimshatsui, Kowloon - Hong Kong
Telephone: 852-2699-2663
Fax: 852-2691-1774

AMPHENOL INTERCONNECT INDIA

PRIVATE LIMITED

105 Bhosari Industrial Area - Pune 411 026 - India
Telephone: 91-20-712-0363/0463/0155
Fax: 91-20-712-0581

AMPHENOL JAPAN MIL/AERO INDUSTRIAL

689-1, Iseochi, Ritto-shi Shiga 520-3044 - Japan
Telephone: 81-77-553-8501
Fax: 81-77-551-2200

AMPHENOL DAESHIN

558 Sosa, SongNea
Bucheon-city, Kyunggi-Do - Korea 420-130
Telephone: 82-32-610-3800
Fax: 82-32-673-2507/665-6219

REST OF THE WORLD

AMPHENOL MEXICO

Prolongacion Reforma 61-6 B2
Col. Paseo de las Lomas - C.P. 013130 Mexico
Telephone: 52-55-5258-9984
Fax: 52-55-5081-6890

AMPHENOL SOUTH AFRICA

30 Impala Road
2196 Chislehurst-Sandton - South Africa
Telephone: 27-11-783-9517 - Fax: 27-11-783-9519

BAR TEC LTD

4 Hagavish St, PO Box 279 - Kfar Saba 44102 -
Israel
Telephone: 972-9-767-4097
Fax: 972-9-767-4324

GESTAS

34630, Besyol Londra Asfalti
Florya is Merkezi Kat.2 - Sefakoy / Istanbul - Turkey
Telephone: 90-212-624-52-29
Fax: 90-212-599-30-68

AMPHENOL ARGENTINA

"Av. Callao 930 2do piso Oficina B "Plaza"
C1023" - AAP Buenos Aires - Argentina
Telephone: 54-11-4815-6886
Fax: 54-11-4814-5779

TFC SOUTH AMERICA

BUENOS AIRES, ARGENTINA

Local Sales Office - Tucuman 540 - Suite 28 "C"
C1049AAL- Buenos Aires - Argentina
Telephone: 54-11-4325-3471
Fax: 54-11-4327-1339

AMPHENOL AUSTRALIA PTY LIMITED

2 Fiveways Blvd., Keysborough
Melbourne, Victoria 3173 - Australia
Telephone: 61-3-8796-8888
Fax: 61-3-8796-8801

AMPHENOL DO BRAZIL

Rua Diogo Moreira, 132, 20 andar, rooms 2001-2-3
CEP: 05423-010 Sao Paulo SP - Brazil
Telephone: 55-11-3815-1003
Fax: 55-11-3815-1629

Amphenol reserves the right to change the content of this document without prior notice

Amphenol
Fiber Optic Solutions

Realisation : wagen:studios - Steven Kilgallon - 01/2004
Printed in France by MenloPark

For more informations, please consult our website :
www.amphenol-fiberopticsolutions.com

DOC-000503-ANG